

SKM 200GB123D

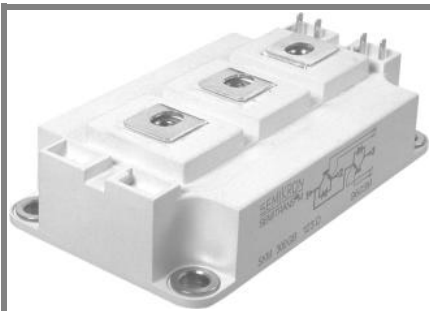

SEMITRANS® 3

IGBT Modules

SKM 200GB123D

SKM 200GAL123D

SKM 200GAR123D

Features

- MOS input (voltage controlled)
- N channel, homogeneous Si
- Low inductance case
- Very low tail current with low temperature dependence
- High short circuit capability, self limiting to $6 \times I_{Cnom}$
- Latch-up free
- Fast & soft inverse CAL diodes
- Isolated copper baseplate using DCB Direct Copper Bonding Technology
- Large clearance (13 mm) and creepage distances (20 mm)

Typical Applications

- AC inverter drives
- UPS

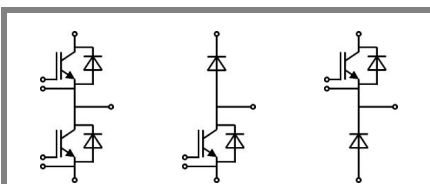

GB

GAL

GAR

Absolute Maximum Ratings		$T_c = 25^\circ\text{C}$, unless otherwise specified		
Symbol	Conditions	Values		Units
IGBT				
V_{CES}	$T_j = 25^\circ\text{C}$	1200		V
I_C	$T_j = 150^\circ\text{C}$	$T_{case} = 25^\circ\text{C}$	200	A
		$T_{case} = 85^\circ\text{C}$	180	A
I_{CRM}	$I_{CRM} = 2 \times I_{Cnom}$	300		A
V_{GES}		± 20		V
t_{psc}	$V_{CC} = 600\text{ V}; V_{GE} \leq 20\text{ V}; T_j = 125^\circ\text{C}$ $V_{CES} < 1200\text{ V}$	10		μs
Inverse Diode				
I_F	$T_j = 150^\circ\text{C}$	$T_{case} = 25^\circ\text{C}$	200	A
		$T_{case} = 80^\circ\text{C}$	130	A
I_{FRM}	$I_{FRM} = 2 \times I_{Fnom}$	300		A
I_{FSM}	$t_p = 10\text{ ms}; \sin.$	$T_j = 150^\circ\text{C}$	1440	A
Freewheeling Diode				
I_F	$T_j = 150^\circ\text{C}$	$T_{case} = 25^\circ\text{C}$	260	A
		$T_{case} = 80^\circ\text{C}$	180	A
I_{FRM}	$I_{FRM} = 2 \times I_{Fnom}$	400		A
I_{FSM}	$t_p = 10\text{ ms}; \sin.$	$T_j = 150^\circ\text{C}$	1800	A
Module				
$I_{t(RMS)}$		500		A
T_{vj}		- 40 ... + 150 (125)		$^\circ\text{C}$
T_{stg}		- 40...+ 125		$^\circ\text{C}$
V_{isol}	AC, 1 min.	2500		V

Characteristics		$T_c = 25^\circ\text{C}$, unless otherwise specified			
Symbol	Conditions	min.	typ.	max.	Units
IGBT					
$V_{GE(th)}$	$V_{GE} = V_{CE}, I_C = 6\text{ mA}$	4,5	5,5	6,5	V
I_{CES}	$V_{GE} = 0\text{ V}, V_{CE} = V_{CES}$		0,1	0,3	mA
V_{CE0}		$T_j = 25^\circ\text{C}$	1,4	1,6	V
		$T_j = 125^\circ\text{C}$	1,6	1,8	V
r_{CE}	$V_{GE} = 15\text{ V}$	$T_j = 25^\circ\text{C}$	7,33	9,33	m Ω
		$T_j = 125^\circ\text{C}$	10	12,66	m Ω
$V_{CE(sat)}$	$I_{Cnom} = 150\text{ A}, V_{GE} = 15\text{ V}$		2,5	3	V
C_{ies}			10	13	nF
C_{oes}	$V_{CE} = 25, V_{GE} = 0\text{ V}$		1,5	2	nF
C_{res}			0,8	1,2	nF
Q_G	$V_{GE} = -8\text{ V} - +20\text{ V}$		1500		nC
R_{Gint}	$T_j = ^\circ\text{C}$		2,5		Ω
$t_{d(on)}$	$R_{Gon} = 5,6\ \Omega$	$V_{CC} = 600\text{ V}$ $I_C = 150\text{ A}$	220	400	ns
t_r			100	200	ns
E_{on}	$R_{Goff} = 5,6\ \Omega$	$T_j = 125^\circ\text{C}$ $V_{GE} = -15\text{ V}$	24		mJ
$t_{d(off)}$			600	800	ns
t_f			70	100	ns
E_{off}			17		mJ
$R_{th(j-c)}$	per IGBT			0,09	K/W

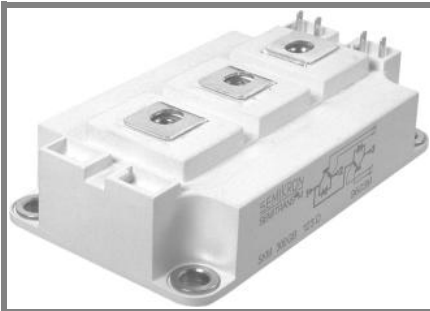

SEMITRANS® 3

IGBT Modules

SKM 200GB123D

SKM 200GAL123D

SKM 200GAR123D

Features

- MOS input (voltage controlled)
- N channel, homogeneous Si
- Low inductance case
- Very low tail current with low temperature dependence
- High short circuit capability, self limiting to $6 \times I_{cnom}$
- Latch-up free
- Fast & soft inverse CAL diodes
- Isolated copper baseplate using DCB Direct Copper Bonding Technology
- Large clearance (13 mm) and creepage distances (20 mm)

Typical Applications

- AC inverter drives
- UPS

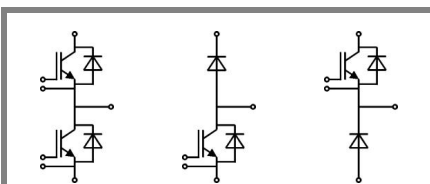

GB

GAL

GAR

Characteristics				min.	typ.	max.	Units
Symbol	Conditions						
Inverse Diode							
$V_F = V_{EC}$	$I_{Fnom} = 150 \text{ A}; V_{GE} = 0 \text{ V}$	$T_j = 25 \text{ }^\circ\text{C}_{chiplev.}$ $T_j = 125 \text{ }^\circ\text{C}_{chiplev.}$		2 1,8		2,5	V V
V_{F0}		$T_j = 25 \text{ }^\circ\text{C}$ $T_j = 125 \text{ }^\circ\text{C}$		1,1		1,2	V V
r_F		$T_j = 25 \text{ }^\circ\text{C}$ $T_j = 125 \text{ }^\circ\text{C}$		6		8,7	mΩ mΩ
I_{RRM} Q_{rr} E_{rr}	$I_F = 150 \text{ A}$ $di/dt = 1500 \text{ A}/\mu\text{s}$ $V_{GE} = -15 \text{ V}; V_{CC} = 600 \text{ V}$	$T_j = 125 \text{ }^\circ\text{C}$		90 8 6,6			A μC mJ
$R_{th(j-c)D}$	per diode					0,25	K/W
Freewheeling Diode							
$V_F = V_{EC}$	$I_{Fnom} = 200 \text{ A}; V_{GE} = 0 \text{ V}$	$T_j = 25 \text{ }^\circ\text{C}_{chiplev.}$ $T_j = 125 \text{ }^\circ\text{C}_{chiplev.}$		2 1,8		2,5	V V
V_{F0}		$T_j = 25 \text{ }^\circ\text{C}$ $T_j = 125 \text{ }^\circ\text{C}$		1,1		1,2	V V
r_F		$T_j = 25 \text{ }^\circ\text{C}$ $T_j = 125 \text{ }^\circ\text{C}$		4,5		6,5	V V
I_{RRM} Q_{rr} E_{rr}	$I_F = 200 \text{ A}$ $di/dt = 2000 \text{ A}/\mu\text{s}$ $V_{GE} = 0 \text{ V}; V_{CC} = 600 \text{ V}$	$T_j = 125 \text{ }^\circ\text{C}$		120 11			A μC mJ
$R_{th(j-c)FD}$	per diode					0,18	K/W
Module							
L_{CE}				15		20	nH
$R_{CC'+EE'}$	res., terminal-chip	$T_{case} = 25 \text{ }^\circ\text{C}$ $T_{case} = 125 \text{ }^\circ\text{C}$		0,35 0,5			mΩ mΩ
$R_{th(c-s)}$	per module					0,038	K/W
M_s	to heat sink M6			3		5	Nm
M_t	to terminals M6, M4			2,5		5	Nm
w						325	g

This is an electrostatic discharge sensitive device (ESDS), international standard IEC 60747-1, Chapter IX.

This technical information specifies semiconductor devices but promises no characteristics. No warranty or guarantee expressed or implied is made regarding delivery, performance or suitability.

SKM 200GB123D

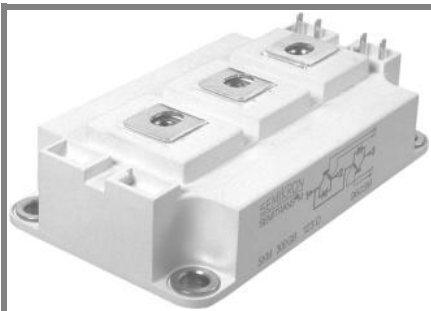

SEMITRANS® 3

IGBT Modules

SKM 200GB123D

SKM 200GAL123D

SKM 200GAR123D

Features

- MOS input (voltage controlled)
- N channel, homogeneous Si
- Low inductance case
- Very low tail current with low temperature dependence
- High short circuit capability, self limiting to $6 \times I_{cnom}$
- Latch-up free
- Fast & soft inverse CAL diodes
- Isolated copper baseplate using DCB Direct Copper Bonding Technology
- Large clearance (13 mm) and creepage distances (20 mm)

Typical Applications

- AC inverter drives
- UPS

Z_{th}		Conditions	Values	Units
$Z_{th(j-c)I}$				
$R_{\theta j-c}$	$i = 1$		59	mk/W
$R_{\theta j-c}$	$i = 2$		23	mk/W
$R_{\theta j-c}$	$i = 3$		6,8	mk/W
$R_{\theta j-c}$	$i = 4$		1,2	mk/W
$\tau_{th(j-c)}$	$i = 1$		0,03	s
$\tau_{th(j-c)}$	$i = 2$		0,0087	s
$\tau_{th(j-c)}$	$i = 3$		0,002	s
$\tau_{th(j-c)}$	$i = 4$		0,0002	s
$Z_{th(j-c)D}$				
$R_{\theta j-c}$	$i = 1$		170	mk/W
$R_{\theta j-c}$	$i = 2$		66	mk/W
$R_{\theta j-c}$	$i = 3$		12	mk/W
$R_{\theta j-c}$	$i = 4$		2	mk/W
$\tau_{th(j-c)}$	$i = 1$		0,0348	s
$\tau_{th(j-c)}$	$i = 2$		0,0072	s
$\tau_{th(j-c)}$	$i = 3$		0,077	s
$\tau_{th(j-c)}$	$i = 4$		0,0002	s

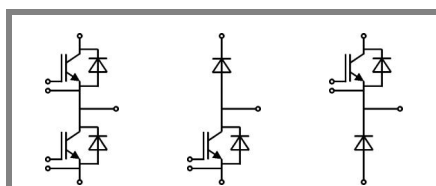

GB

GAL

GAR

SKM 200GB123D

UL Recognized

CASED56

File 63 532

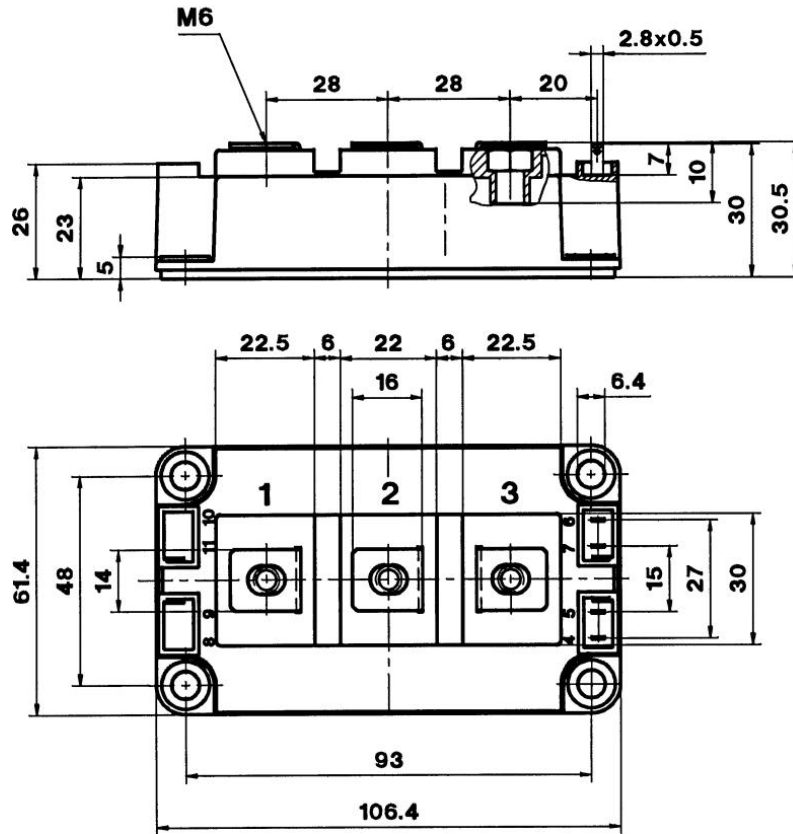

Case D 56

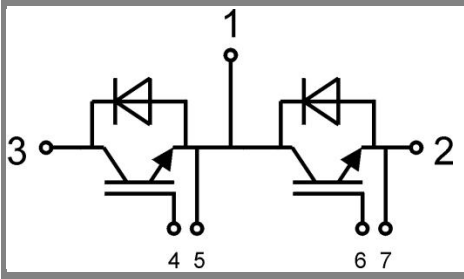

Case D 56

GB

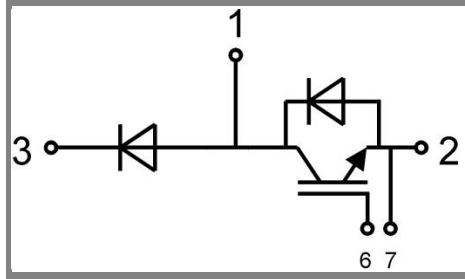

Case D 57

GAL

(56)

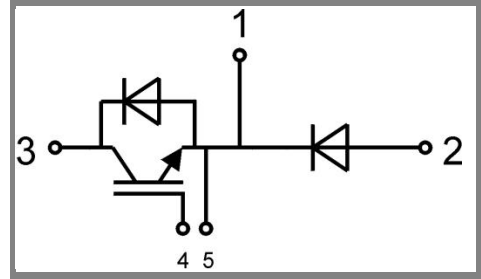

Case D 58

GAR

(56)